

HD Live Camera

HD Live Camera

User Manual
(V1.0)

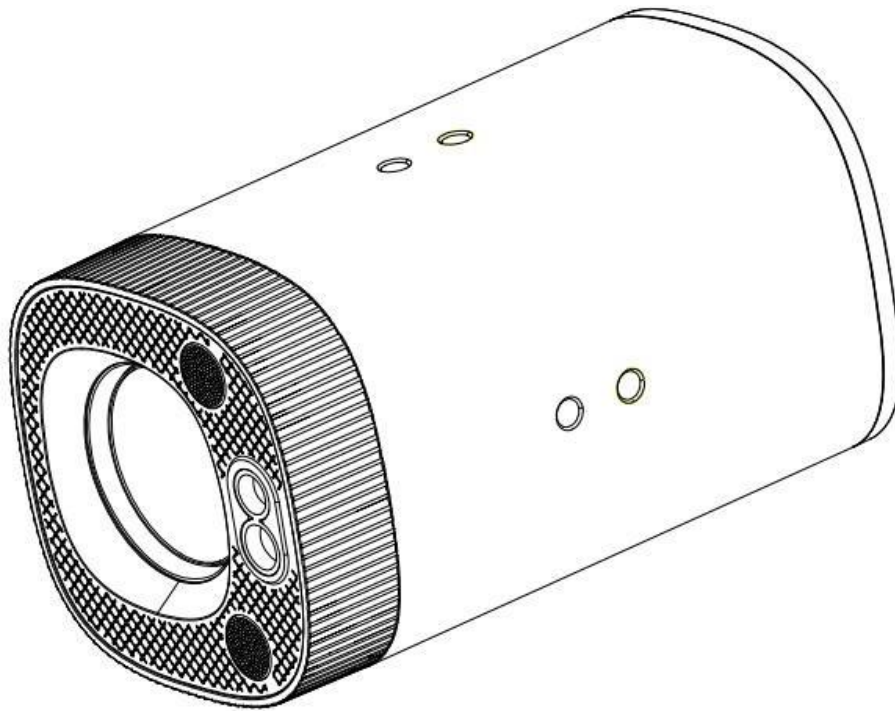

Preface



This manual is to ensure that the user can use the product properly and avoid danger while operating. Before using this product, please read the user manual carefully and keep it properly for future reference

Overview

This manual is about HD Live camera operation

Graphic Symbols

Description of graphic symbols used in this manual

Symbols	Description
 Illustration	This symbol indicates that the words are clarification or supplement to this article.
 Caution	This symbol indicates that negligence of the instructions may lead to mishandling that may cause injury or property damage.
 Danger	This symbol indicates a risk that may result in damage to this machine or documents. Follow the instructions to avoid property damage.

Attention

This manual introduces functions, installations and operations for this product in details. Please read this manual carefully before installation and use.

Precautions:

This product can only be used in the specified conditions in order to avoid any damage to the camera:

- 1) Do not expose the product to rain or moisture.
- 2) To prevent the risk of electric shock, do not open the case. Installation and maintenance should only be carried out by qualified technicians.
- 3) Do not use the product beyond the specified temperature, humidity or power supply specifications.
- 4) Please use a soft dry cloth to clean the camera. If the camera is very dirty, clean it with diluted neutral detergent; do not use any type of solvents, which may damage the surface.

Electrical Safety:

Installation and use of this product must strictly comply with local electrical safety standards.

Transportation:

Avoid any stress, vibration, or moisture during transportation, storage, installation and operation

Installation:

- 1) Do not rotate the camera head violently, otherwise it may cause mechanical failure;
- 2) This product should be placed on a stable desktop or other horizontal surface. Do not install the product obliquely, otherwise it may display inclined image;
- 3) Ensure there are no obstacles within rotation range of the holder.
- 4) Do not power on before completely installation.

Do Not Dismantle Camera:

We are not responsible for any unauthorized modification or dismantling.

Magnetic Interference

Electromagnetic fields at specific frequencies may affect the video image. This product is Class A. It may cause radio interference in household application. Appropriate measure is required.

Content

1. Quick Start	1
1.1 Camera Overview	1
1.2 Power-on Initial Configuration	1
1.2.1 Power on	1
1.2.2 Initial Configuration	1
1.3 Video Output	1
2. Product Overview	3
2.1 Product Introduction	3
2.1.1 Dimension	3
2.1.2 Accessory	3
2.2 Product Feature	3
2.3 Technical Specification	4
2.4 Wiring Connection	7
2.4.1 Back Panel	7
3. How to Use	8
3.1 Remote Control	8
3.1.1 Hot to Use Remote Control	8
3.2 Menu Setting	9
3.2.1 Main Menu	9
4. Maintenance and Troubleshooting	15
4.1 Camera Maintenance	15
4.2 Troubleshooting	15

1. Quick Start

1.1 Camera Overview

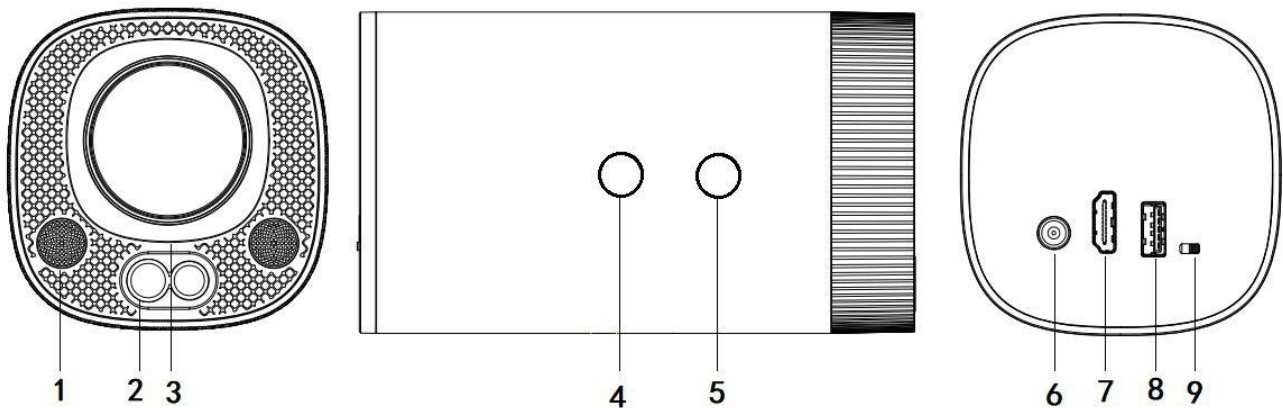

Figure1-1 Interface

Interface Introduction :

- | | | |
|---------------------|--------------------------|----------------------|
| 1. Built in pick-up | 4. Screw Hole for Tripod | 7. HDMI Interface |
| 2. Focusing Aux | 5. Tripod Screw Hole | 8. USB 3.0 Interface |
| 3. Lens | 6. Power Switch | 9. DIP Switch |

1.2 Power-on Initial Configuration

1.2.1 Power on

Connect device to power socket with DC12V power adapter

1.2.2 Initial Configuration

The movement first shrinks and then stretches after power on, finally returns to the front, and the camera is normally identified on the computer, indicating that the self-checking is completed.

1.3 Video Output

1) HDMI Video Output

- HDMI video cable connection: as shown in Figure1.1 label 7

b. Connect the camera and the monitor via HDMI video cable, and the video output is available after the camera self-test.

2) USB3.0 Video Output

a. USB 3.0 video cable connection: as shown in Figure1.1 label 8

b. Connect the camera and the computer via USB3.0 video cable, open the video software and select the image device to output the video.

2. Product Overview

1.4 Product Introduction

1.4.1 Dimension

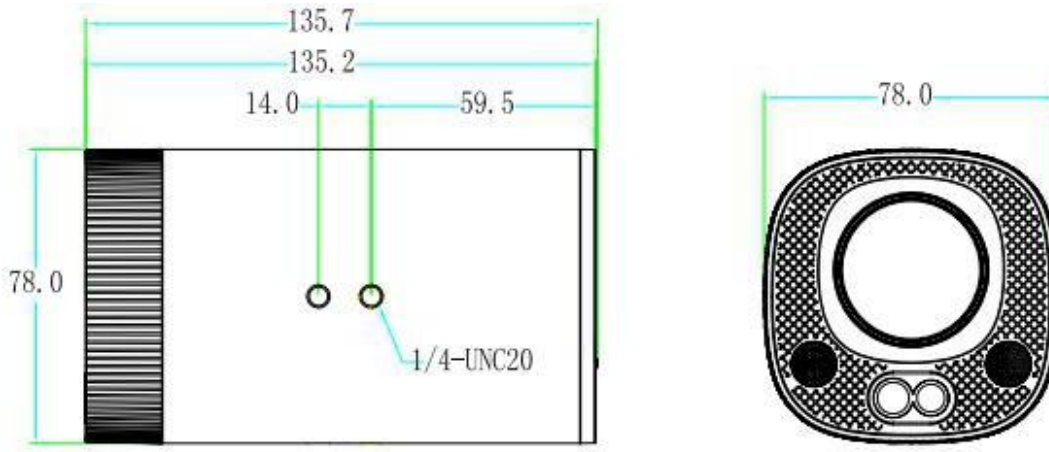

Figure1-2 Product Dimension

1.4.2 Accessory

When you unpack your package, check that all the supplied accessories are included:

Table1-1 Supplied Accessory

Supplied Accessory	Wireless Remote Control
	User Manual
	USB3.0 Cable
	Warranty Card

1.5 Product Feature

This product is a new HD camera for live broadcasting industry. It has perfect functions, superior performance and rich video output interfaces. Featuring with advanced ISP processing algorithms, offering vivid and high resolution video with a strong sense of depth and fantastic color rendition. The camera is stable and reliable, and easy to operate and maintain. It is suitable for various live scene applications.

- **Full HD Resolution:** 1/2.8 inch high quality CMOS sensor. Resolution is up to 1920x1080 with frame rate up to 60fps.
- **Optical Zoom Lens:** 10X optical zoom lens and 68.8° wide angle lens.
- **Multiple Video Interfaces:** HDMI, USB3.0; Simultaneously output audio and video signal
- **Leading Auto Focus Technology:** Fast, accurate and stable auto focusing technology.
- **Horizontal and Vertical Screen:** Support to switch the horizontal screen and vertical screen output mode via DIP Switch, to better meet customers' demands.
- **Professional Image Style:** Support the beauty and jewelry style mode, and adjust the best image effect for live scenes.
- **Built-in pickup:** Built-in 2 MIC pickups, can pick up the sound 6 meters in the omnidirectional direction (the best pickup distance is 3 meters), the unique noise suppression algorithm makes your voice perfectly presented.
- **Multiple Audio/Video Compression Standards:** Support YUY2/NV12/MJPG/H.264/H.265 video compression format.
- **Low Noise and High SNR:** Super high SNR image is achieved with low noise CMOS. Advanced 2D/3D noise reduction technology further reduces the noise while ensuring high image clarity.
- **Easy to use:** No need to download drivers, USB output is plug and play, with a convenient and concise user experience.

1.6 Technical Specification

Table1-2 Camera Lens Parameter

Parameter/Model	
Camera Lens	
Sensor	1/2.8 inch sensor
Effective Pixels	2.07 M, 16 : 9
Video Signal	HDMI : 1080P60、 1080P50、 1080P30、 1080P25、 720P60、 720P50、 1080P59.94、 1080P29.97、 720P59.94 ;

	<p>USB3.0 :</p> <p>Landscape Mode :</p> <p>YUY2/NV12:1920×1080/1280×720/1024×576/960×540/800×600/800×448/640×480/640×360/480×270@30/25/20/15/10/5fps ;</p> <p>MJPEG/H264:1920×1080/1600×896/1280×720/1024×576/800×600/800×448/720×576/720×480/640×480/640×360/352×288@30/25/20/15/10/5fps ;</p> <p>Portrait Mode :</p> <p>YUY2/NV12:1080×1920/720×1280/576×1024/600×800/448×800/480×640/360×640/270×480/180×320@30/25/20/15/10/5fps ;</p> <p>MJPEG/H264:1080×1920/896×1600/720×1280/576×1024/600×800/448×800/576×720/480×720/480×640/360×640/288×352@30/25/20/15/10/5fps</p>
Viewing Angle	8.8°(T) ~ 68°(W)
Focal Length	f=4.34mm ~ 41.66mm
Iris	F1.85 ~ F2.63
Optical Zoom	10X
Minimum Illumination	0.1Lux(F1.8, AGC ON)
DNR	2D & 3D
White Balance	Auto/Manual/One-push White Balance/Specified Color Temperature 【2400K~7100K】
Focus	Auto/Manual/One-push
Exposure	Auto/Manual/Shutter Priority/Iris Priority/Brightness Priority

BLC	On/Off
SNR	≥50dB
Portrait Mode Switch	On/Off
Focus Aux	On/Off
Minimum Object Distance	10cm(W) ~ 100cm(N)

Table1-3 Interface Parameter

Interface Parameter	
Video Output	1XUSB : Type A , support audio output ; HDMI output, support audio output
Video Compression Formats	YUV, NV12, MJPG, H.264
Audio Input	2 Channels Built-in MIC Pickup
Control	USB

Table1-4 Other Parameter

Other Parameter			
Working Voltage/Current	Voltage	Power Adapter	12
		USB	5V
	Current	Power Adapter	0.425
		USB	1A(max)
Power Consumption	5W(max)		
Storage Temperature	-10°C ~ +60°C		

Storage Humidity	20% ~ 90%
Working Temperature	-10°C ~ +50°C
Working Humidity	20% ~ 80%
Dimension(L*W*D)	135.7mm×78 mm×78mm
Weight	0.6kg
Environment	Indoors
Accessory	User Manual, USB3.0 Cable, Power Adapter, Wireless Remote Control

1.7 Wiring Connection

1.7.1 Back Panel

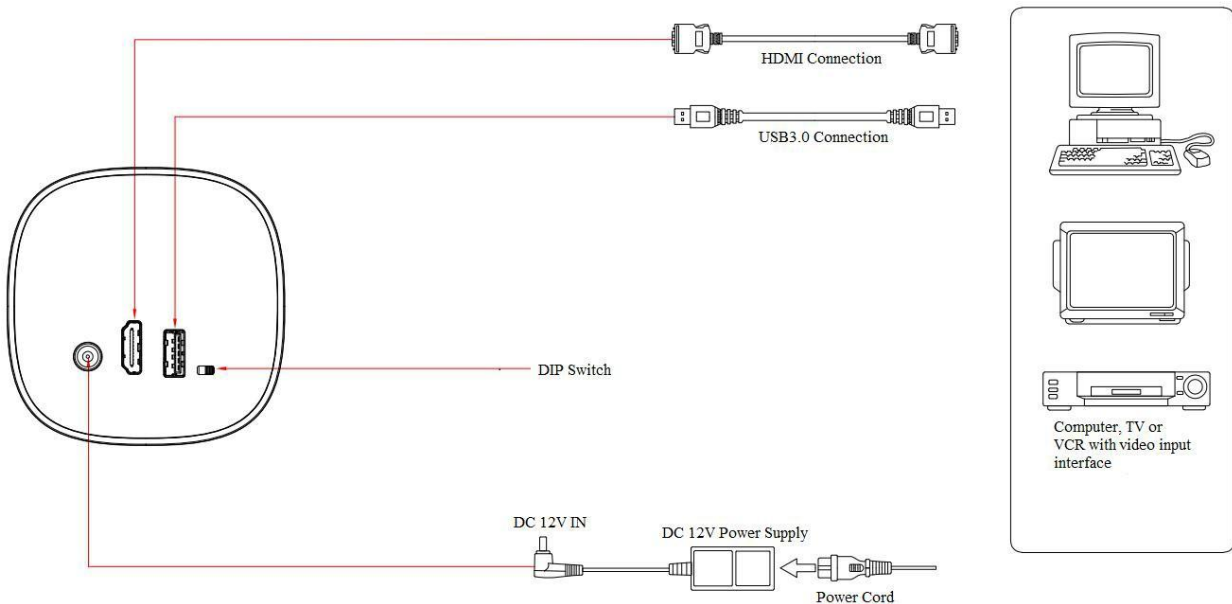











Figure1-3 Wiring Diagram

3. How to Use

1.8 Remote Control

1.8.1 Hot to Use Remote Control

<p>1. Standby </p> <p>Press and hold 3 seconds to enter the standby mode, and again press and hold 3 seconds to let the camera self test and back to HOME.</p>	
<p>2. Menu </p> <p>Enter/Exit OSD menu or return to the upper directory</p>	
<p>3. Number Buttons</p> <p>Set or call 1-3 preset position; Press the number button and hold 3 seconds to set the preset. If same preset is required to set, the old one need to be clear.</p>	
<p>4. Focus Control </p> <p>[Auto Focus]: Default auto focus. (In auto focus mode, buttons [Focus +] and [Focus -] invalid</p> <p>[Manual Focus]: Press AF button to enable manual focus mode. Buttons [Focus +] and [Focus -] are to adjust focus. Press AF button again to switch to auto focus mode.</p>	
<p>5. Zoom Control </p> <p>[ZOOM +]: Zoom in; [ZOOM -]: Zoom out</p>	
<p>6. Direction Buttons</p> <p>Up, down, left, right arrows: Control PTZ to move and menu adjustment</p>	
<p>7. Code Pairing</p> <p>Press  and  at the same time and hold 3 seconds. After release the buttons, the indicator keeps flashing, which means the code start to be paired. The receiver power on, when the code paired successfully, the indicator will turn off.</p>	
<p>8. Code Clearing</p>	

Press  and  at the same time and hold 3 seconds and the indicator start flashing. Restart the receiver, and then the indicator turn off, meaning that the code is cleared.

1.9 Menu Setting

1.9.1 Main Menu

In normal working mode, press **【MENU】** key to display the menu, using scroll arrow to point at or highlight the selected items.

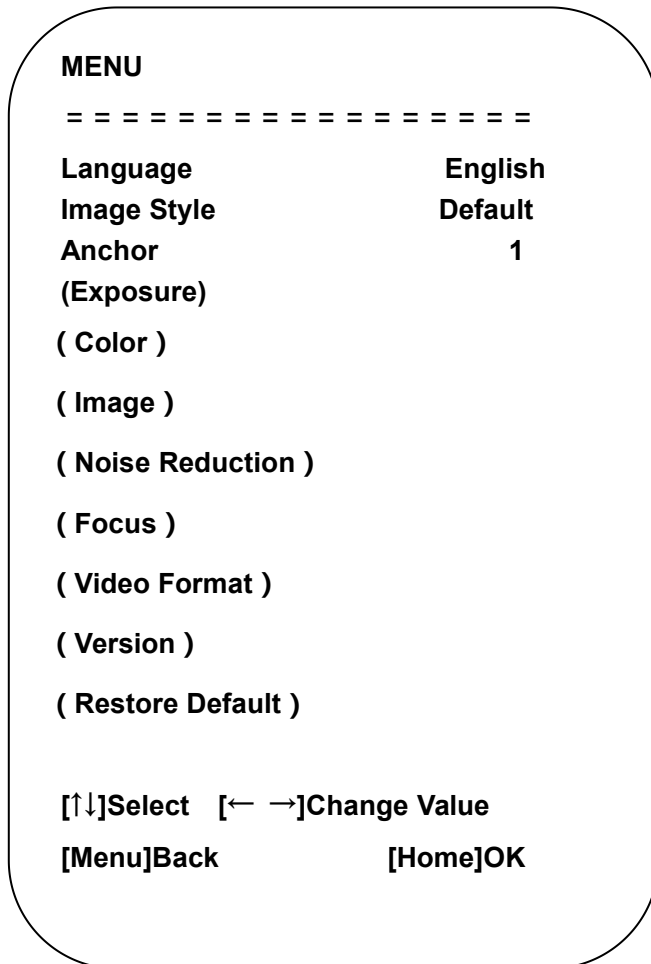

1) Language:

Move the pointer to (Language) in the main menu, and press the [←→] key to modify language.

2) Image Style:

Move the pointer to (Image Style) in the main menu, and press the [←→] key to modify the style default / Beauty / Jewelry

3) Anchor:

Move the pointer to (Anchor) in the main menu, and press the [←→] key to modify the 1-4 host numbers; Image parameters can be modified manually under different host numbers, and can be saved after power failure.

4) Exposure Setting

Move the pointer to the (EXPOSURE) in the Main Menu, click the【HOME】key and enter into the (Exposure sub menu) as shown below,

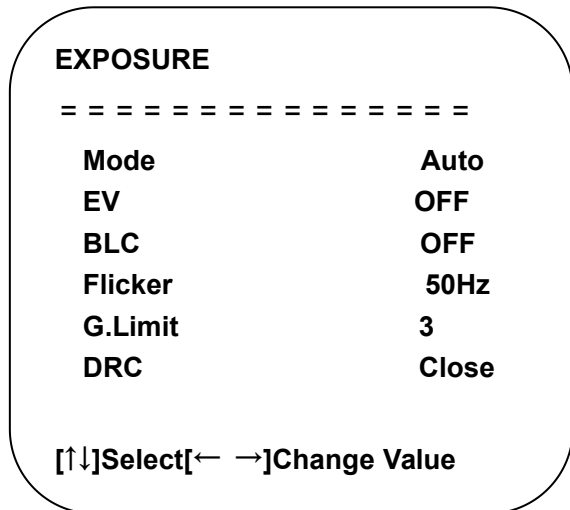

Mode: Auto, Manual, Shutter priority Iris priority and Brightness priority.

EV: On/Off (only available in auto mode)

Compensation Level: -7~7 (only available in auto mode when EV is ON)

BLC: ON/OFF for options (only available in auto mode)

Anti-Flicker: OFF/50Hz/60Hz for options (only available in Auto/Iris priority/Brightness priority modes)

Gain limit: 0~15(only available in Auto/ Iris priority /Brightness priority mode)

WDR: Off, 1~8

Iris: F1.8、 F2.0、 F2.4、 F2.8、 F3.4、 F4.0、 F4.8、 F5.6、 F6.8、 F8.0、 F9.6、 F11 off.

Shutter Priority: 1/30、 1/50、 1/60、 1/90、 1/100、 1/120、 1/180、 1/250、 1/350、 1/500、 1/1000、 1/2000、 1/3000、 1/4000、 1/6000、 1/10000 (only available in Manual and Shutter priority mode)

Brightness: 0~20(only available in Brightness priority mode)

Gain Limit: 0-15 (Only valid in auto, and shutter priority mode)

5) Color

Move the pointer to the (COLOR) in the Main Menu, click the **【HOME】** and enter the (COLOR sub menu)

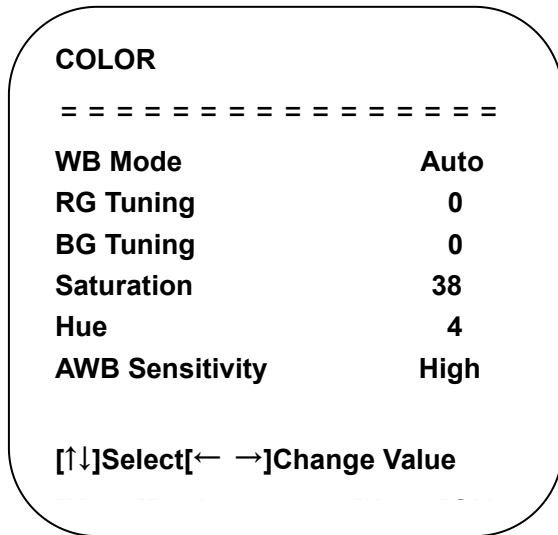

WB Mode: Auto, Manual, One Push, Specified color temperature

Saturation: 0-127, specified temperature (2400k-7100k, interval 100)

Red fine-tuning: -10~10 (only available in automatic mode)

Blue fine-tuning: -10~10 (only available in automatic mode)

RED GAIN: 0~100(only available in Manual mode)

BLUE GAIN: 0~100(only available in Manual mode)

AWB Sensitivity: high/middle/low

Chroma: 0~8

6) Image

Move the pointer to the (IMAGE) in the Menu, click the **【HOME】** and enter into the (IMAGE sub menu) as follow,

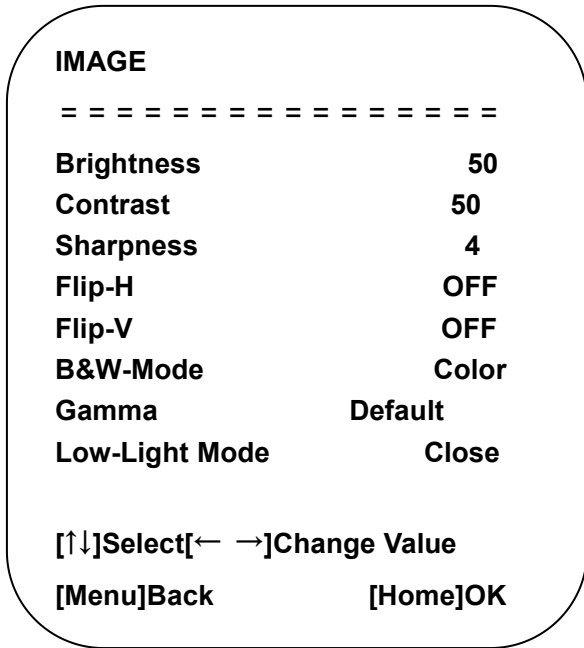

Brightness: 0~100

Contrast: 0~100

Sharpness: 0~15

Flip-H: On/Off

Flip-V: On/Off

B&W Mode: color, black/white

Gamma: Default/0.45/0.50/0.55/0.63

Minimum Illumination: On/Off

7) Noise Reduction

Move the pointer to the (NOISE REDUCTION) in the Menu, click the 【 HOME 】 and enter the (NOISE REDUCTION) as follow,

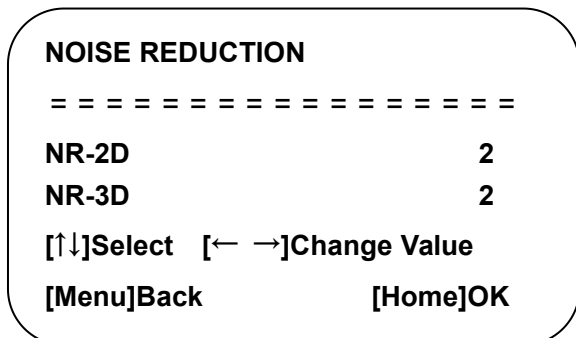

2D Noise Reduction: Auto, close, 1~7

3D Noise Reduction: Close, 1~8

8) Focus

Move the pointer to the (FOCUS) in the Menu, click the **【HOME】** and enter the (FOCUS) as follow

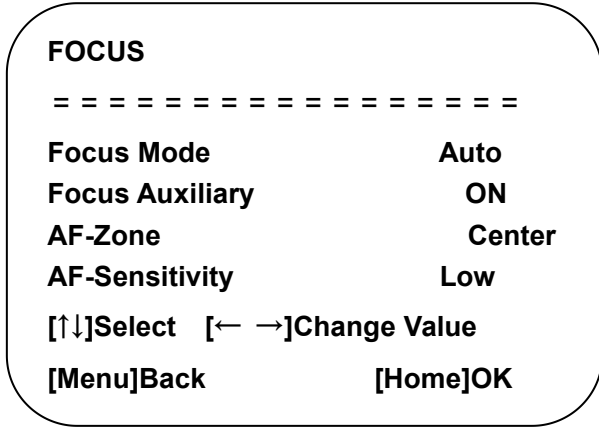

Focus Mode: Auto/manual

Focus Auxiliary On/Off

AF-Zone: Up/center/down/all

AF-Sensitivity: High/medium/low

9) Video Format

Move the pointer to the (Video Format) in the Menu, click the **【HOME】** and enter the (Video Format) as follow

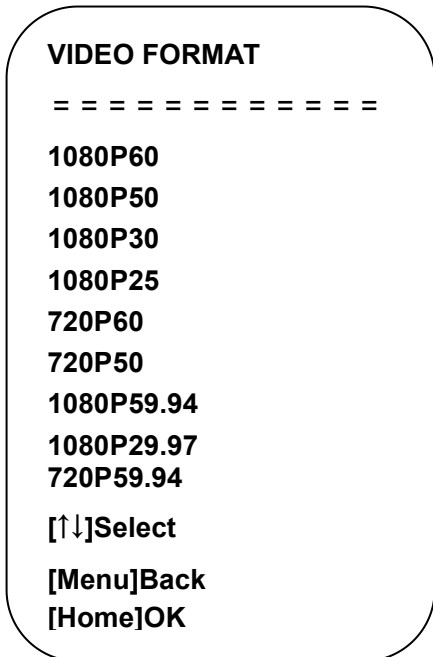

10) Version

Move the pointer to the (VERSION) in the Main Menu, click the **【HOME】** and enter the (VERSION) as follow

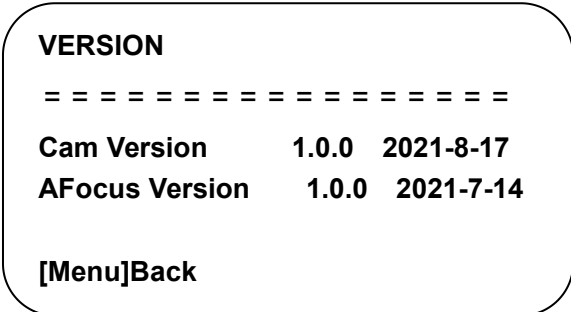

11) Restore Default

Move the pointer to the (RESTORE DEFAULT) in the Main Menu, click the **【HOME】** and enter the (RESTORE DEFAULT) as follow

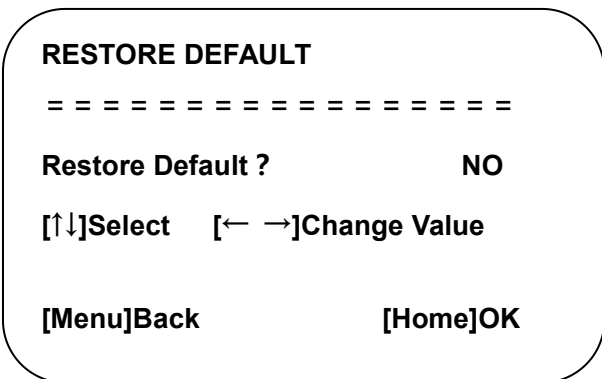

Restore default: YES/NO.

Restore factory default only restores the image parameters under the current host number (Language, color style and video format cannot be restored to factory default)

4. Maintenance and Troubleshooting

1.10 Camera Maintenance

- a) Please power off the camera and disconnect the power adapter and socket, if it's not used for a long run.
- b) Use soft cloth or tissue to clean the camera cover.
- c) Wipe it with a soft, dry cloth when cleaning the camera lens. Wipe it gently with a mild detergent if needed. Do not use strong or corrosive detergents to avoid scratching the lens and affecting the video quality.

1.11 Troubleshooting

1) No video output

- a. Check whether the device is connected to the USB cable and whether the power indicator is on
- b. Check whether the device is in standby state, long press the power button for 3s to see whether it can be turned on
- c. Whether the device could do self-check after restarted
- d. Restart the computer to check whether it is normal
- e. Check whether the video output cable is normal
- f. Check whether the device is recognized normally, unload the device and reload when it is displayed in the device manager

2) Intermittent Image Output

- a. Check whether the USB cable is normal and the USB cable is connected properly

3) Remote control does not works

- a. Re-code the wireless remote control to the camera
- b. Remote control address is set to 1 (if the machine is set back to the factory defaults, remote control addresses need to be back to 1 too)
- c. Check whether the battery is installed on the remote controller or low power, Check the camera working mode is the normal operating mode